

**ML110G6**

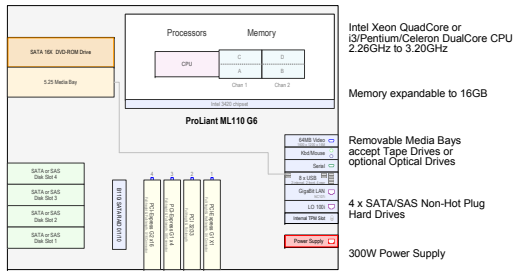

Intel Xeon QuadCore or i3/Pentium/Celeron DualCore CPUs 2.26GHz to 3.20GHz

Memory expandable to 16GB

Removable Media Bays accept Tape Drives or optional Optical Drives

4 x SATA/SAS Non-Hot Plug Hard Drives

300W Power Supply

**ML110G7**

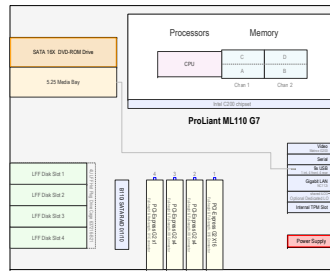

Intel Xeon QuadCore or i3/Pentium DualCore CPUs 2.6GHz to 3.5GHz

Memory expandable to 16GB

Removable Media Bays accept Tape Drives or optional Optical Drives

4 x SATA/SAS Non-Hot Plug Hard Drives

**ML150 G6**

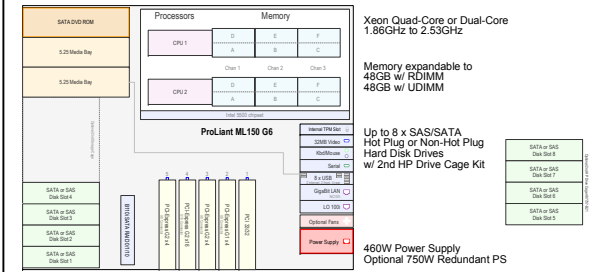

Xeon Quad-Core or Dual-Core 1.86GHz to 2.53GHz

Memory expandable to 48GB w/ RDIMM 48GB w/ UDIMM

Up to 8 x SAS/SATA Hot Plug or Non-Hot Plug Hard Disk Drives w/ 2nd HP Drive Cage Kit

460W Power Supply  
Optional 750W Redundant PS

**ML310 G5p**

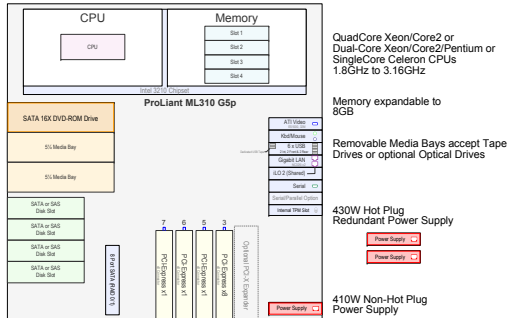

QuadCore Xeon/Core2 or DualCore Xeon/Core2/Pentium or SingleCore Celeron CPUs 1.86GHz to 3.16GHz

Memory expandable to 8GB

Removable Media Bays accept Tape Drives or optional Optical Drives

430W Hot Plug Redundant Power Supply

410W Non-Hot Plug Power Supply

**ML330 G6**

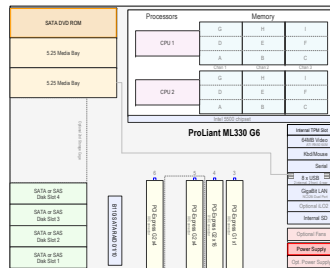

Up to 2 Six-Core, Quad-Core or Dual-Core Xeon CPUs 1.6GHz to 2.66GHz

Memory expandable to 192GB w/ RDIMM 48GB w/ UDIMM

Removable Media Bays accept Tape Drives or optional Optical Drives

Up to 8 x SAS/SATA Hot Plug or Non-Hot Plug Hard Disk Drives w/ 2nd HP Drive Cage Kit

460W Power Supply  
Optional 750W Redundant PS

**ML350 G6**

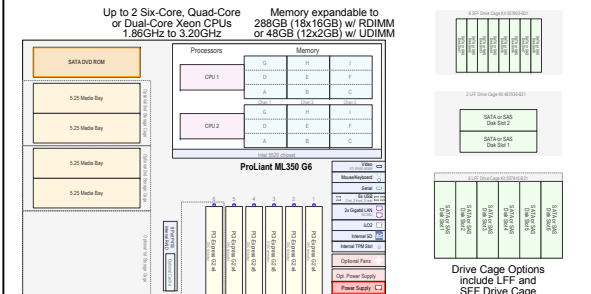

Up to 2 Six-Core, Quad-Core or Dual-Core Xeon CPUs 1.86GHz to 3.20GHz

Memory expandable to 288GB (18x16GB) w/ RDIMM or 48GB (12x4GB) w/ UDIMM

Up to 8 x SAS/SATA Hot Plug or Non-Hot Plug Hard Disk Drives w/ 2nd HP Drive Cage Kit

460W Power Supply  
Optional 750W Redundant PS

Dual Common Slot Bays

Drive Cage Options include LFF and SFF Drive Cage

**ML370 G6**

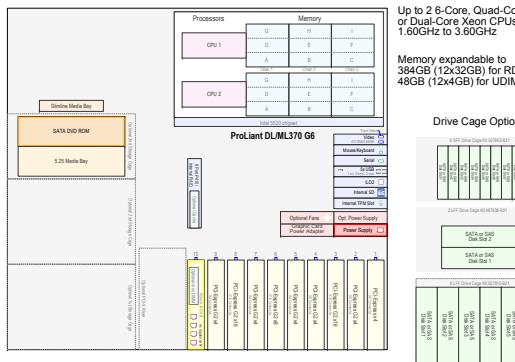

Up to 2 6-Core, Quad-Core or Dual-Core Xeon CPUs 1.60GHz to 3.60GHz

Memory expandable to 384GB (12x32GB) for RDIMM or 48GB (12x4GB) for UDIMM

Drive Cage Options

460W Power Supply

**Note:** HS = Hot Swap  
HP = Hot Plug  
NHP = Non Hot Plug

This Visual Solution Document is deemed to be valid and accurate as of the date shown below.

The information contained herein is subject to change without notice and is provided "as is" without warranty of any kind. Please consult the Product QuickSpecs Documents on [www.hp.com](http://www.hp.com) for any updates to the product information contained herein after the date shown below.



Build with the latest Logical shapes from the Visio Café - Download the latest HP Intel Stencils to get the shapes used above to create your own customized Visual Solution Documents - Feedback: [info@visiocafe.com](mailto:info@visiocafe.com)